



● Thank you for purchasing our product. Before installing, please read the instruction carefully and keep it for future reference.

⚠ Attention!

- For installation, please follow the steps described in manual. Any damage caused by wrong installation shall be imputed to the users.
- Don't break or modify the wire. To avoid the short circuit, please don't pull the wire when installing.
- Do not disassemble or change any parts excluding the manual description.
- The interior examination or maintenance should be executed by our professionals.

◎ MARK MEANING:

NOTE You could get the installation details from the information behind the mark.

⚠ Some processes must be followed to avoid the affection caused by wrong installation.

⚠ **WARNING!** Some processes must be followed to avoid damages to yourself or the public.

⚠ **CAUTION!** Some processes must be followed to avoid the damage to the vehicle.



1-1 Accessories

1 Meter X1 	2 Main wiring harness X1 	3 Passive speed sensor X1 	4 M8 / S type speed sensor bracket X1
5 M10 / S type speed sensor bracket X1 	6 M5x5xP0.8 Hexagon screw X2 	7 2.5 mm Allen key X1 	8 D6xH5 mm magnet x6
9 Meter bracket X1 	10 M4X12Lmm Screw X2 	11 M5X15 screw X2 	12 M5 washer X2
13 4.0 mm Allen key X1 			

NOTE Contact your local distributor, if the items received in the box are not the same as the items listed above.

1-2 Option accessory

1 Reed Sensor

NOTE Some optional accessories may not be sold in your area. For more details, please contact your local distributor.

2-1 Wiring Installation Instructions

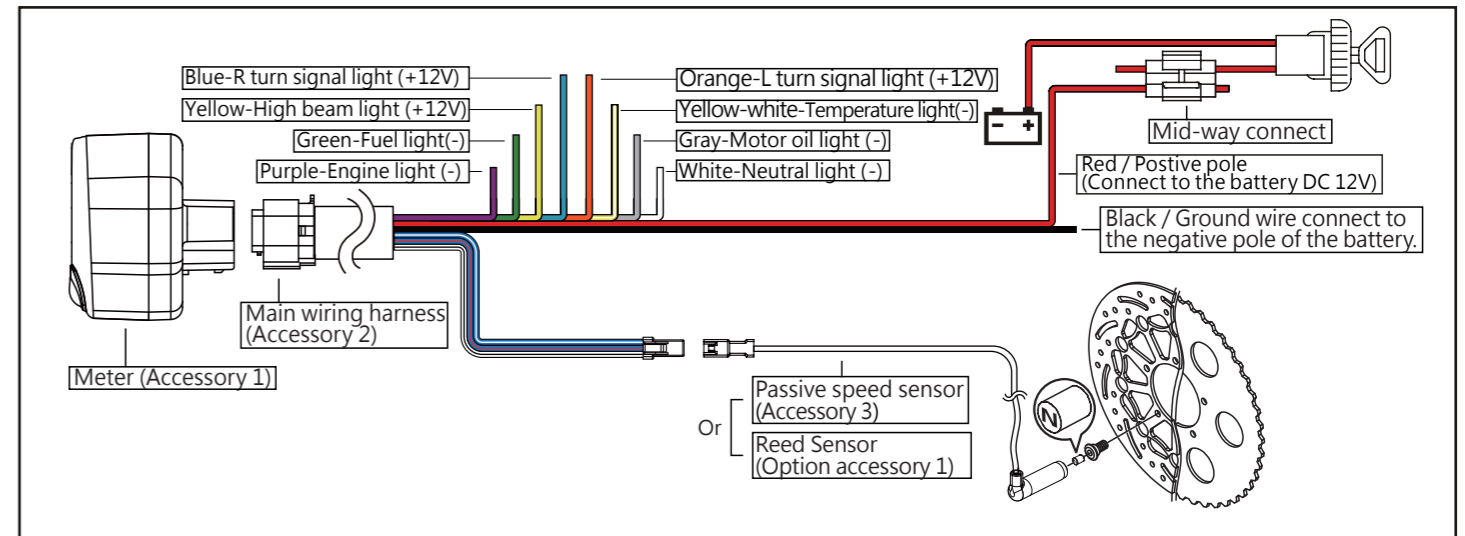

MOTO / SCOOTER S type speed sensor bracket instruction

- Loose the screw on the caliper.
- Install the S type bracket on the caliper.
- Adjusting the distance between the sensor and screw to get the best speed signal. Please make sure the distance is under 2 mm to get the best signal.
- Please adjust the bracket to the proper angle and then screw it up. Please make sure the disc screw could pass the hole on the bracket for you to install the sensor into the same hole for catching the speed signal.

⚠ When using the electronic speed sensor (Hall Sensor), the meter must connect with DC 12V battery instead of using inner battery from the meter.

⚠ When using Reed Sensor, the meter could function normally when using only the inner battery.

2-2 Installation instruction

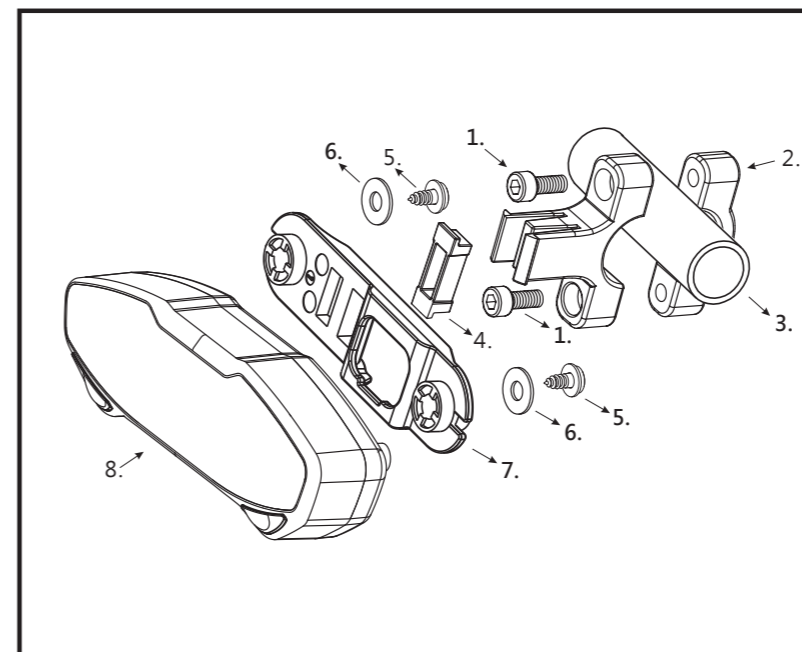

Follow this procedure for proper installation.

1. M5X15 screw X2 (Accessory 11)
2. Meter bracket for handle bar (Accessory 9)
3. Fix the bracket on handle bar
4. Meter bracket clip (Accessory 9)
5. M4X12Lmm Screw X2 (Accessory 10)
6. M5 washer X2 (Accessory 12)
7. Meter fixed board (Accessory 9)
8. Meter (Accessory 1)

NOTE Adjust the meter to the proper viewing angle before tightening the Allen screw.

Special instruction for meter fit board.

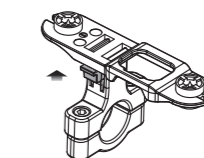

A. Push meter bracket clip up to lock meter fix board (with meter) on bracket.

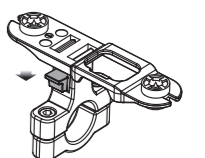

B. Push meter bracket clip down to release meter fix board (with meter) on bracket.

3-1 Basic Function Instruction

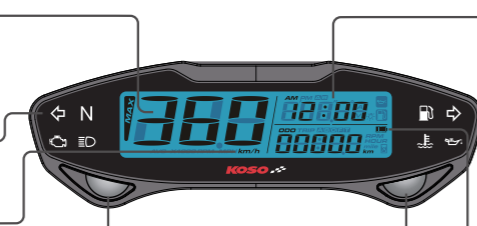

Speedometer

- Display range : 0~360 km/h(0~225 MPH).
- Display unit : 1 km/h (MPH) for alternative.

Indicator light

- Right indication light (Green)
- Motor oil light (Red)
- Low fuel warning light (Amber)
- Water temperature light (Red)
- Neutral light (Green)
- High beam light (Blue)
- Left indication light (Green)
- Engine light (Amber)

Inner battery

- Display range : 4 levels.

Adjust button

- Press the Adjust button on the main screen to switch between ODO, Trip A · B, Total Hour meter, Hour meter A · B.

Select button

- Press the Select button on the main screen to switch between Clock, Stopwatch, Volt meter, Average record.

MAX Record

- Average speed : 0~360 km/h(0~225 MPH)
- Max speed : 0~360 km/h(0~225 MPH)
- Max voltage : DC 8.0~18.0 V

Inner battery Level

- Display range : 4 Levels

Operating temperature

- -10 + 60 °C

Specification

- JIS D 0203 S2

Meter Size

- 120.0 x 38.8 x 34.2 mm

Meter Weight

- Around 70 g

Indicator

- Right indication light (Green)
- Motor oil light (Red)
- Low fuel warning light (Amber)
- Water temperature light (Red)
- Neutral light (Green)
- High beam light (Blue)
- Left indication light (Green)
- Engine light (Amber)









Odo meter

- Display range : 0~99,999 km(mile).
- Display unit : 1 km(mile).

Trip meter

- Display range : 0.0~9,999.9 km(mile), automatically reset after 9,999.9 km(mile).
- Display unit : 0.1 km(mile).

3-2 Functions, Settings Description

● Speedometer	Display range : 0 ~ 360 km/h(0~225 MHP) Display unit : 1 km/h(MHP), for alternative.	● MAX Record	Average speed : 0~360 km/h(0~225 MPH) Max speed : 0~360 km/h(0~225 MPH) Max voltage : DC 8.0~18.0 V
● Odometer	Display range : 0 ~ 99,999 km(mile), Automatically reset after 99,999 km(mile) Display unit : 1 km(mile)	● Inner battery Level	Display range : 4 Levels
● Trip meter A · B	Display range : 0.0 ~ 9,999.9 km(mile), Automatically reset after 9,999.9 km(mile) Display unit : 0.1 km(mile)	● Operating temperature	-10 + 60 °C
● Hour meter	Display range : 0~99,999 hour Display unit : 1 hour	● Specification	JIS D 0203 S2
○ Hour meter A · B	Display range : 0~9,999.9 hour, Automatically reset after 9,999.9 hour Display unit : 0.1 hour	● Meter Size	120.0 x 38.8 x 34.2 mm
● Clock	Display range : 00:00~23:59	● Meter Weight	Around 70 g
● Volt meter	Display range : DC 8.0 ~ 18.0 V Display unit : DC 0.1 V	● Indicator	Right indication light (Green)  Motor oil light (Red)  Low fuel warning light (Amber)  Water temperature light (Red)  Neutral light (Green)  High beam light (Blue)  Left indication light (Green)  Engine light (Amber) 
● Stopwatch	Setting range : 0'00"00~9'59"99 Setting unit : 0.01 sec.	NOTE Any design and specification changes, will not be notify.	
● Maintenance Mileage	Setting range : 300 ~ 5,000 km, may be cleared manually. Setting unit : 1 km		

3-3 Battery replacement

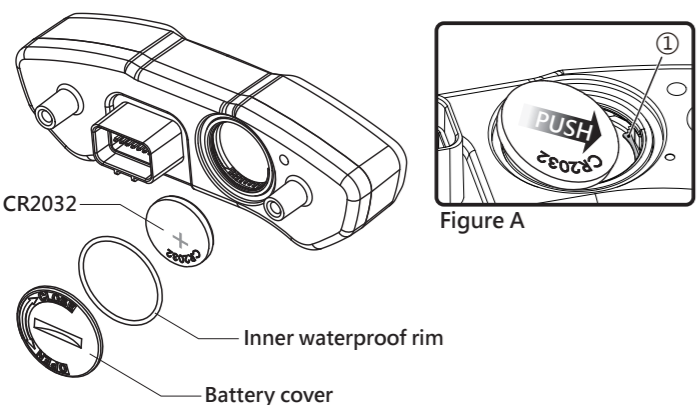

Follow this procedure for proper installation.

- The meter includes an internal battery(CR2032).This battery shall be replaced only when power runs out.
- In order to install the battery properly, push the battery as show on Figure A to make sure the battery is placed underneath the ① metal tab.

⚠ WARNING! Not following this procedure could result in permanent damage to the meter.

4 Switch Function Instructions

● Instructions for select button



- Press the **Select button** while on main screen to switch from Clock to Stopwatch.
- Press and hold the **Select button** for **3 seconds** to alternate 12/24 hour modes.

NOTE If 24 hour mode is chosen, then the AM/PM symbol will not be displayed.



- Press the **Select button** to switch from Stopwatch to Volt meter.
- Press and hold the **Select button** for **3 seconds** to reset the Stopwatch.

NOTE When the option for manually resetting the stopwatch is chosen, press Select button and hold for 6 sec. to switch to Average record.



- Press the **Select button** to switch from Volt meter to Average record.



- Press the **Select button** to switch from Average record to clock meter.
- Press and hold the **Select button** for **3 seconds** to reset all records.

NOTE Average speed and the Max speed display in the 3 seconds rotation.

NOTE When Maintenance Symbol is ON, please reset under this function screen.

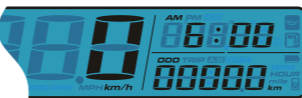

- Back to clock screen.

● Instructions for adjust button



- While on odometer screen, press the **Adjust button** to switch from odometer to trip A.
- While on odometer screen, press and hold the **Adjust button** for 3 seconds to change the speed unit.



- Press the **Adjust button** to switch from trip A to trip B.
- Press and hold the **Adjust button** for 3 seconds to reset the trip A.



- Press the **Adjust button** to switch from trip B to total hour meter.
- Press and hold the **Adjust button** for 3 seconds to reset the trip B.



- Press the **Adjust button** to switch from total hour meter to hour meter A.



- Press the **Adjust button** to switch from hour meter A to hour meter B.
- Press and hold the **Adjust button** for 3 seconds to reset the hour meter A.



- Press the **Adjust button** to exit from hour meter B and to go back to odometer screen.
- Press and hold the **Adjust button** for 3 seconds to reset the hour meter B.



- Back to the odometer screen.

3 Setting Mode

● While on main screen, press the **Adjust+Select** buttons for 3 seconds to enter the tire circumference and sensing point settings.(for setting a different tire size.)

● The tire circumference and sensing point settings.

● Press the **Adjust** button to set the proper tire circumference.

3-1-1 The circumference setting

● Example : To set the circumference at 1,300 mm.

● Press the **Adjust** button to move to the digit you want to set.

● Press the **Adjust** button to set the proper tire circumference.

NOTE Setting range : 300~2,500 mm
Setting unit : 1 mm

NOTE Default value : 1,000 mm

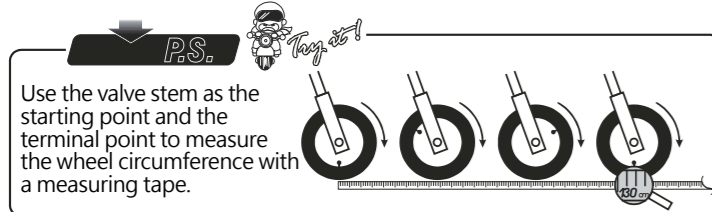

● EX : Set the circumference from 300 mm to 1,300 mm.

● Press the **Select** button to choose the setting number.

● Press the **Adjust** button to enter the sensing point setting.

3-1-2 The sensing point setting

● Example : To set the sensor point at 6P.

● Press the **Adjust** button to move to the digit you want to set.

NOTE Setting range : 1~60P

NOTE Default value : 1P

● EX : Set the sensor point from 1P to 6P.

● Press the **Select** button to choose the setting number.

● Press the **Adjust** button to go back to tire circumferences and sensing point setting screen.

● Press the **Select** button to switch from **a 1** to **a 2** screen.

● Press the **Adjust** button to enter the clock(Hour) setting.

3-2-1 The clock (Hour) setting

● Example : The hours have to be set to 14.

● Press the **Select** button to choose the hour you want to set.

NOTE Setting range : 1~12 (12H)
0~23 (24H)

NOTE Cursor moving order is :
Hour → Digit in ten minutes
→ Digit in minutes

● EX : Set hour from 00:00 to 14:00.

● Press the **Adjust** button to enter the minute setting.

3-2-2 The clock (minute) setting

● Example : To set time(minute) as 05 minutes.

● Press the **Select** button to choose the minute you want to set.

NOTE Setting range : 00~59 minutes.

● EX : Set minute from 0 minute to 5 minutes.

● Press the **Adjust** button to go back to Clock setting screen.

● Press the **Select** button to switch from **a 2** to **a 3** screen.

● Press the **Adjust** button to enter the Stopwatch setup.

3-3 Stopwatch setup

● Example : To select the manual stopwatch mode.

● Press the **Select** button to choose the setting option.

● If AUTO option is chosen, press the **Adjust** button to exit the Stopwatch setup.

NOTE Setting range : AUTO/SW(Switch)

NOTE Default value : AUTO

NOTE Under " AUTO " mode, the timer will start automatically when riding.

● EX : The Stopwatch mode is changed from AUTO to SW(Switch).

● Press the **Adjust** button to go back to Stopwatch setup screen.

● Press the **Select** button to switch from **a 3** to **a 4** screen.

● Press the **Adjust** button to enter the maintenance oil light setting.

3-4 Maintenance Oil Light Setting

● Example : Select ON/OFF to enable /disable the maintenance oil light function .

● Press the **Select** button to choose the setting option.

● If OFF is selected, then press the **Adjust** button once to exit the maintenance mileage setting.

NOTE Default value : OFF

● If ON is chosen, press the **Adjust** button to enter the maintenance oil light setting.

● Press the **Adjust** button to move to the digit you want to set.

● Press the **Adjust** button to go back to maintenance oil light setting screen.

● Press the **Select** button to switch from **a 4** to **a 5** screen.

● Press the **Adjust** button to enter the Backlight brightness setting.

3-5 Backlight brightness setting

● Example : To change the Backlight brightness setting to 1.

● Press the **Select** button to adjust the brightness of the backlight.

NOTE Setting range : 1~5

NOTE Default value : 5

● EX : The Backlight brightness setting is changed from 5 to 1.

● Press the **Adjust** button to go back to Backlight brightness setting screen.

● Press the **Select** button to switch from **a 5** to **a 6** screen.

● Press the **Adjust** button to enter the ODO setting.

3-6 ODO setting

● Example : To set the customized mileage adjustment under USER.

● Press the **Select** button to switch from internal ODO inspect to USER ODO setting.

● Press the **Adjust** button to enter the internal ODO inspect setting.

● EX : Currently internal ODO inspect as 5,000 km.

⚠ User unable to adjust or clear internal ODO.

● Press the **Adjust** button to enter the USER ODO setting.

● Example : To set USER ODO value to 3,000 km.

● Press the **Adjust** button to move to the digit you want to set.

● Press the **Select** button to choose the setting number.

NOTE Setting range : 00,000~99,999 km
Setting unit : 1 km

NOTE Default value : 0 km

● EX : Set USER ODO value from 0 km to 3,000 km.

● Press the **Adjust** button to go back to ODO setting screen.

● Press the **Adjust+Select** buttons for 3 seconds to exit and go back to the main screen.

● Back to the main screen.

4 Trouble Shooting

The following situations do not indicate malfunction of the meter. Please check the following points, before taking it in for repairs.

Trouble	Check item	Trouble	Check item
The meter doesn't work when the power is on.	<ul style="list-style-type: none"> ● The power does not supply to the meter. →Please make sure the wiring is connected. The wiring and fuse are not broken. →The battery is broken or the battery is too old to supply enough power (DC 12 V) to make the meter work. 	Speedometer does not display or display error.	<ul style="list-style-type: none"> ● May be poor connection of the speed sensor or poor conduction. →Please make sure the speed sensor is connected correctly. ● May be setting error. →Please check the 3-1 tire circumference and sensing point settings.
The meter shows wrong information.	<ul style="list-style-type: none"> ● Maybe the problem is caused by the insufficient power. →Please change the inner battery(CR2032). ● Maybe the problem is caused by wrong battery installation. →Please check is the battery direction is correct. 	The clock is incorrect.	<ul style="list-style-type: none"> ● Maybe the problem is caused by the insufficient power. →Please change the inner battery(CR2032). ● May be setting error. →Please check the 3-2 clock setting.

※ If the problem persists after reviewing the options above, please contact your local distributor.